

Key
 D – Door
 R – Render
 r – Railings
 S – Stone
 W – Window

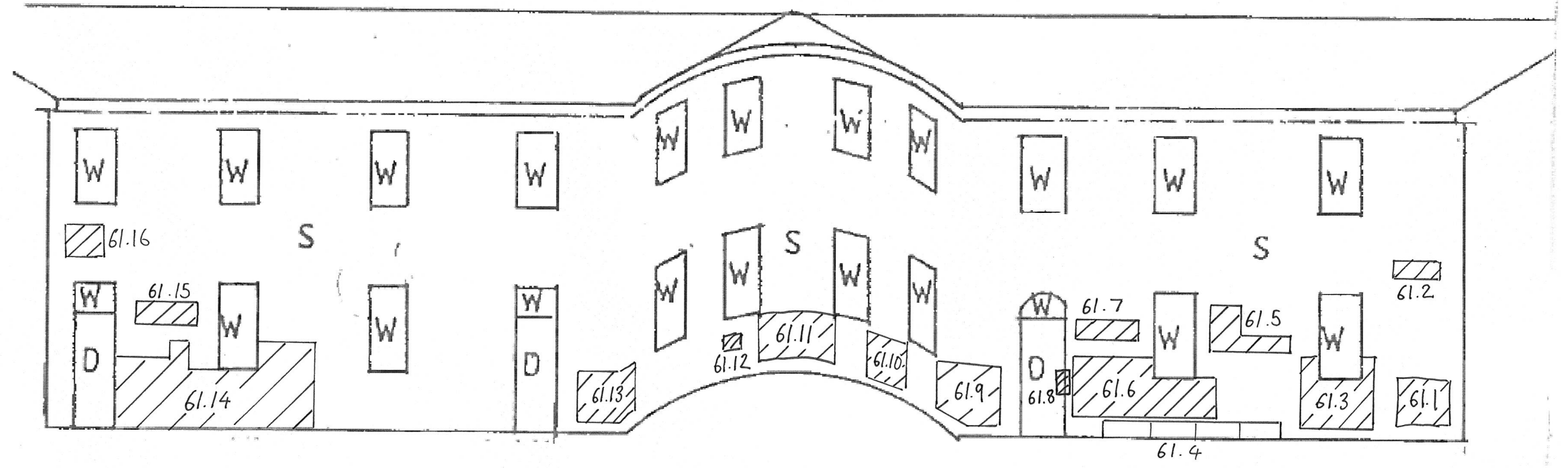

ELEVATION 61
 (See layout plan for elevation reference.)

Key
 D - Door
 R - Render
 r - Railings
 S - Stone
 W - Window

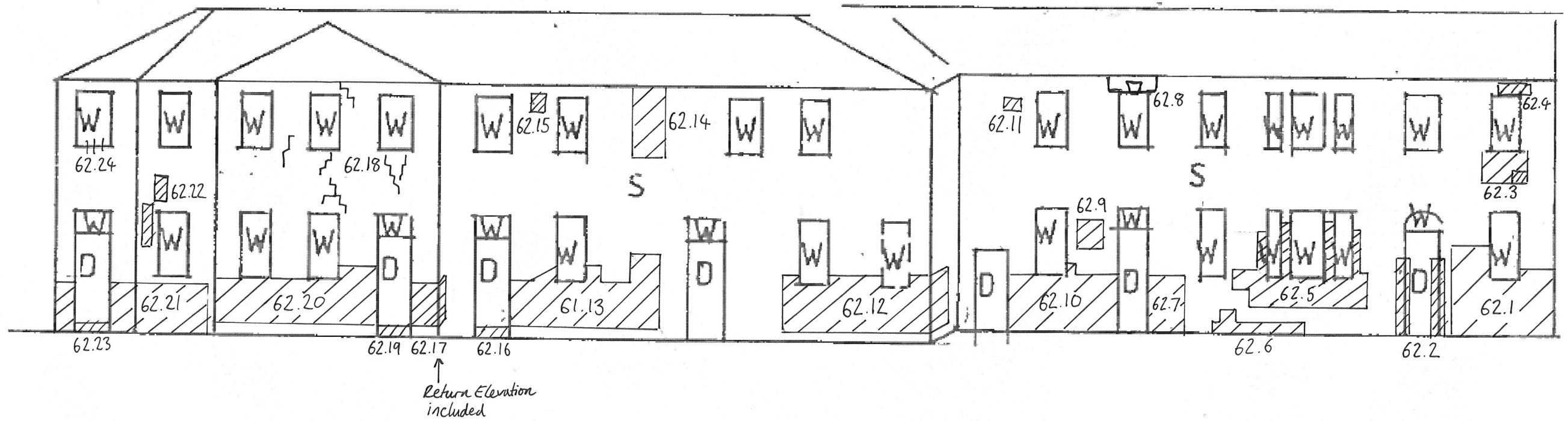

ELEVATION 62
 (See layout plan for elevation reference.)

Key

D – Door

R – Render

r – Railings

S - Stone

W - Window

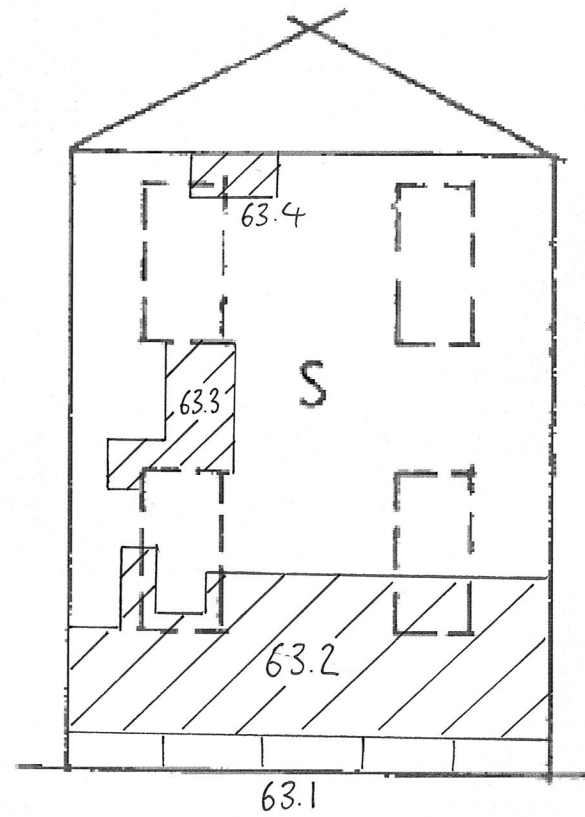

ELEVATION 63

(See layout plan for elevation reference.)

Key
 D - Door
 R - Render
 r - Railings
 S - Stone
 W - Window

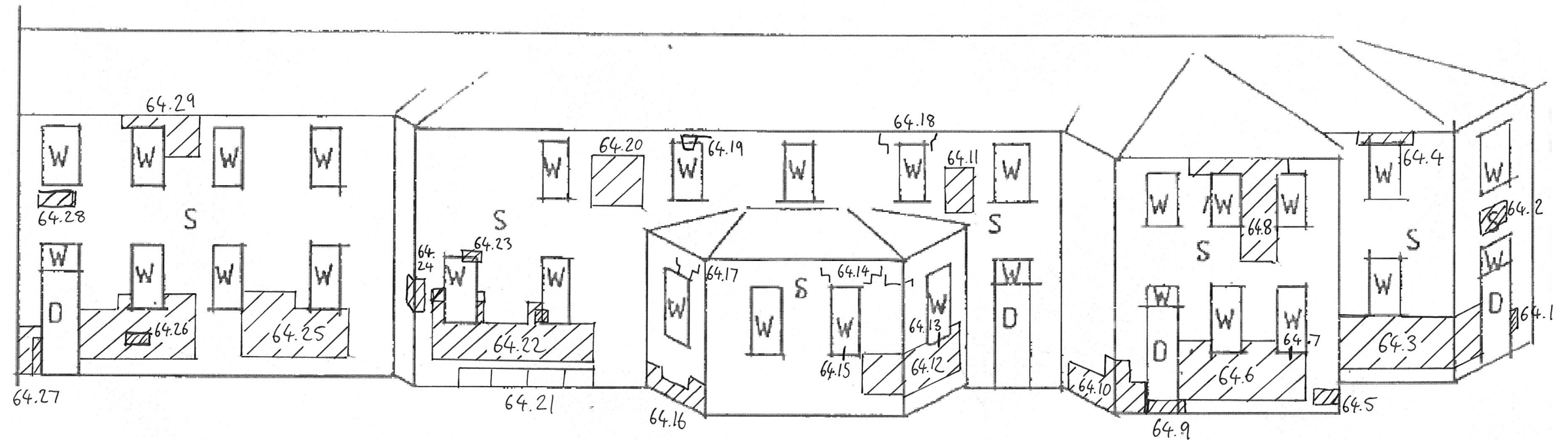

ELEVATION 64
 (See layout plan for elevation reference.)

Key
 D – Door
 R – Render
 r – Railings
 S - Stone
 W - Window

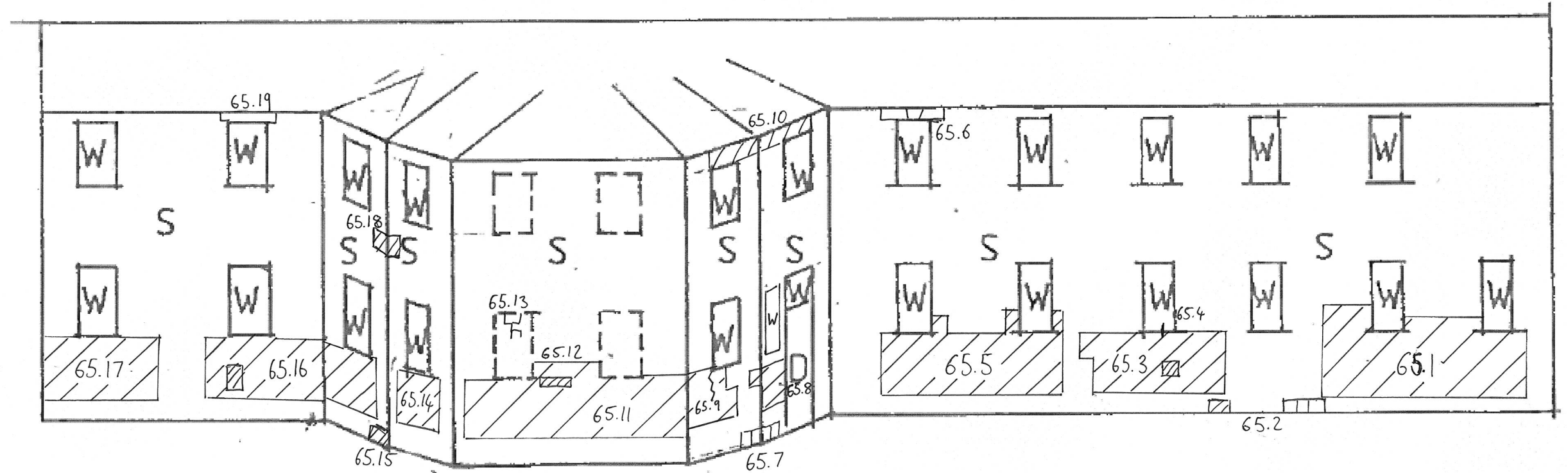

ELEVATION 65
 (See layout plan for elevation reference.)

Key
D - Door
R - Render
r - Railings
S - Stone
W - Window

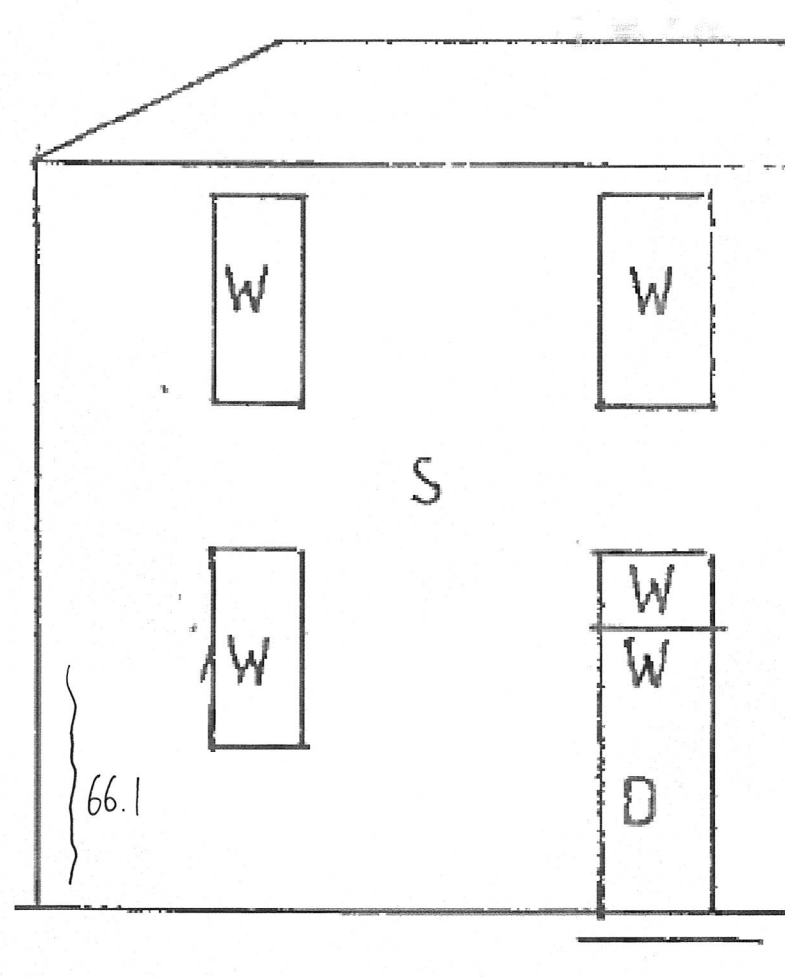

ELEVATION 66

(See layout plan for elevation reference.)

Key
D – Door
R – Render
r – Railings
S - Stone
W - Window

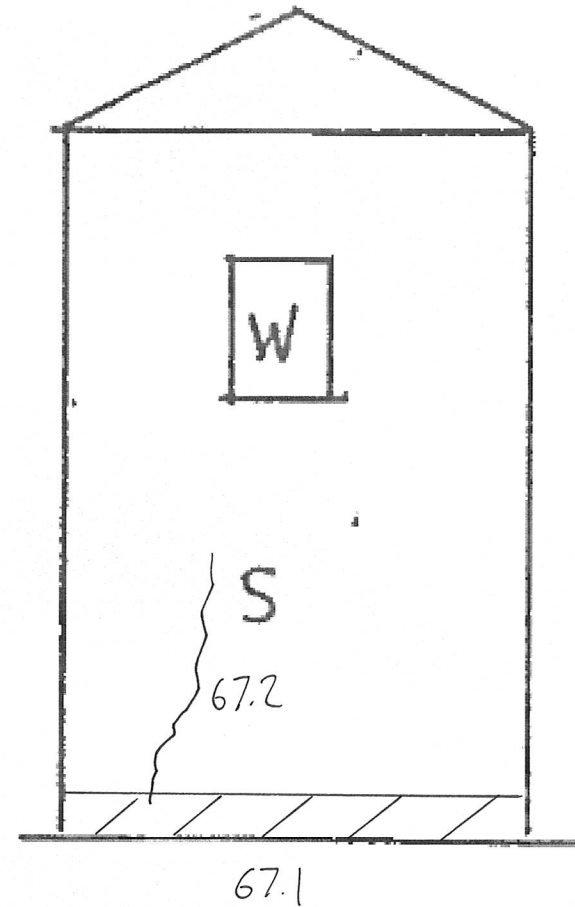

ELEVATION 67

(See layout plan for elevation reference.)

Key
D – Door
R – Render
r – Railings
S - Stone
W - Window

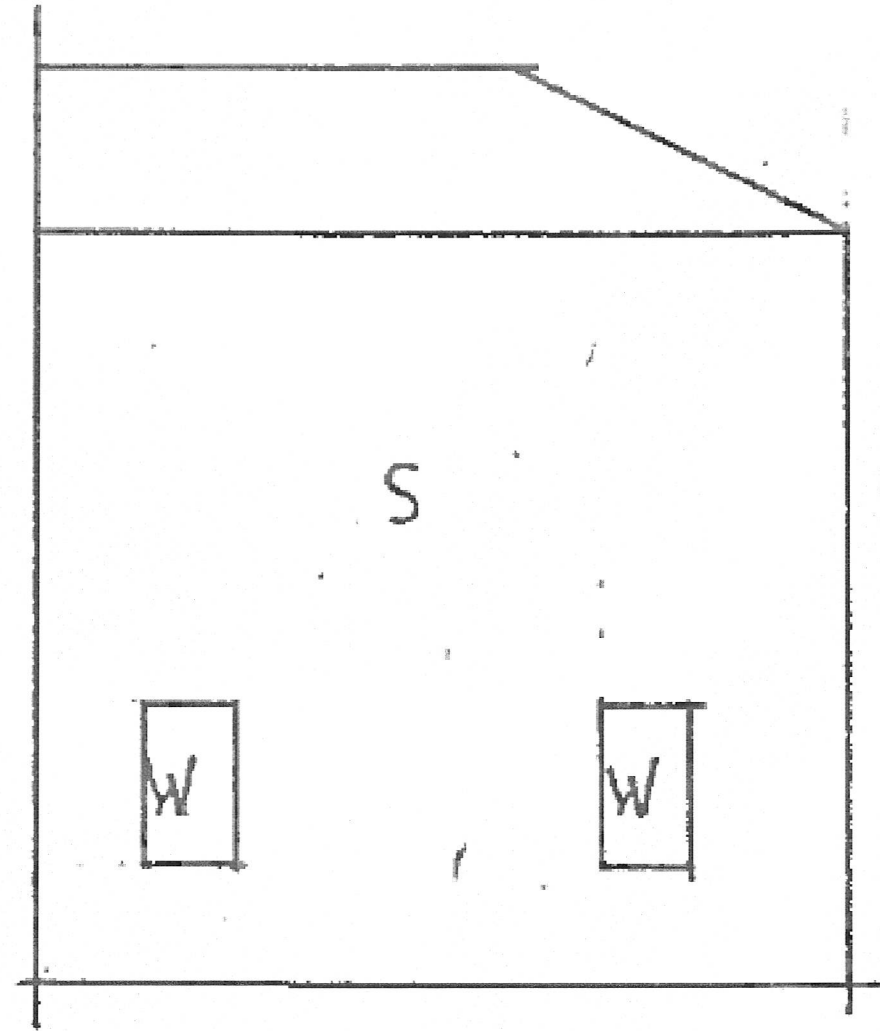

ELEVATION 68

(See layout plan for elevation reference.)

Key
D - Door
R - Render
r - Railings
S - Stone
W - Window

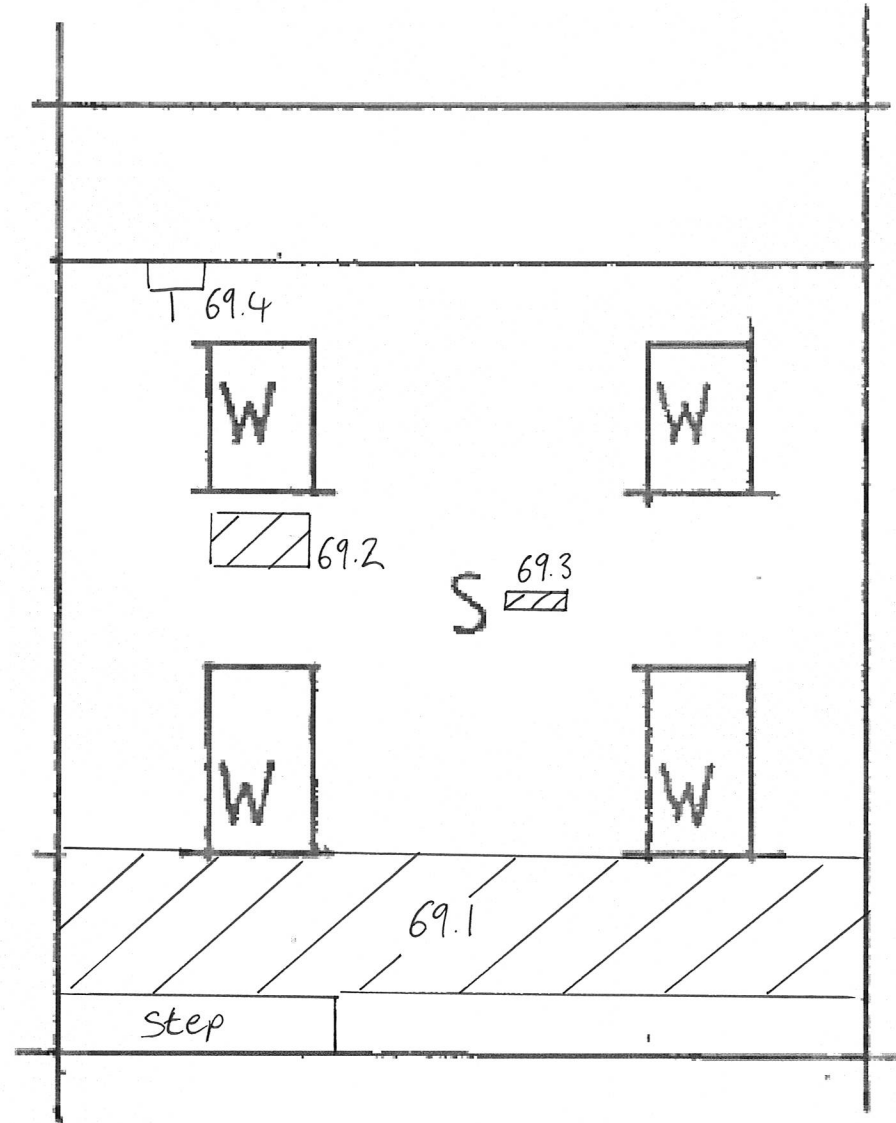

ELEVATION 69

(See layout plan for elevation reference.)

Key
 D – Door
 R – Render
 r – Railings
 S - Stone
 W - Window

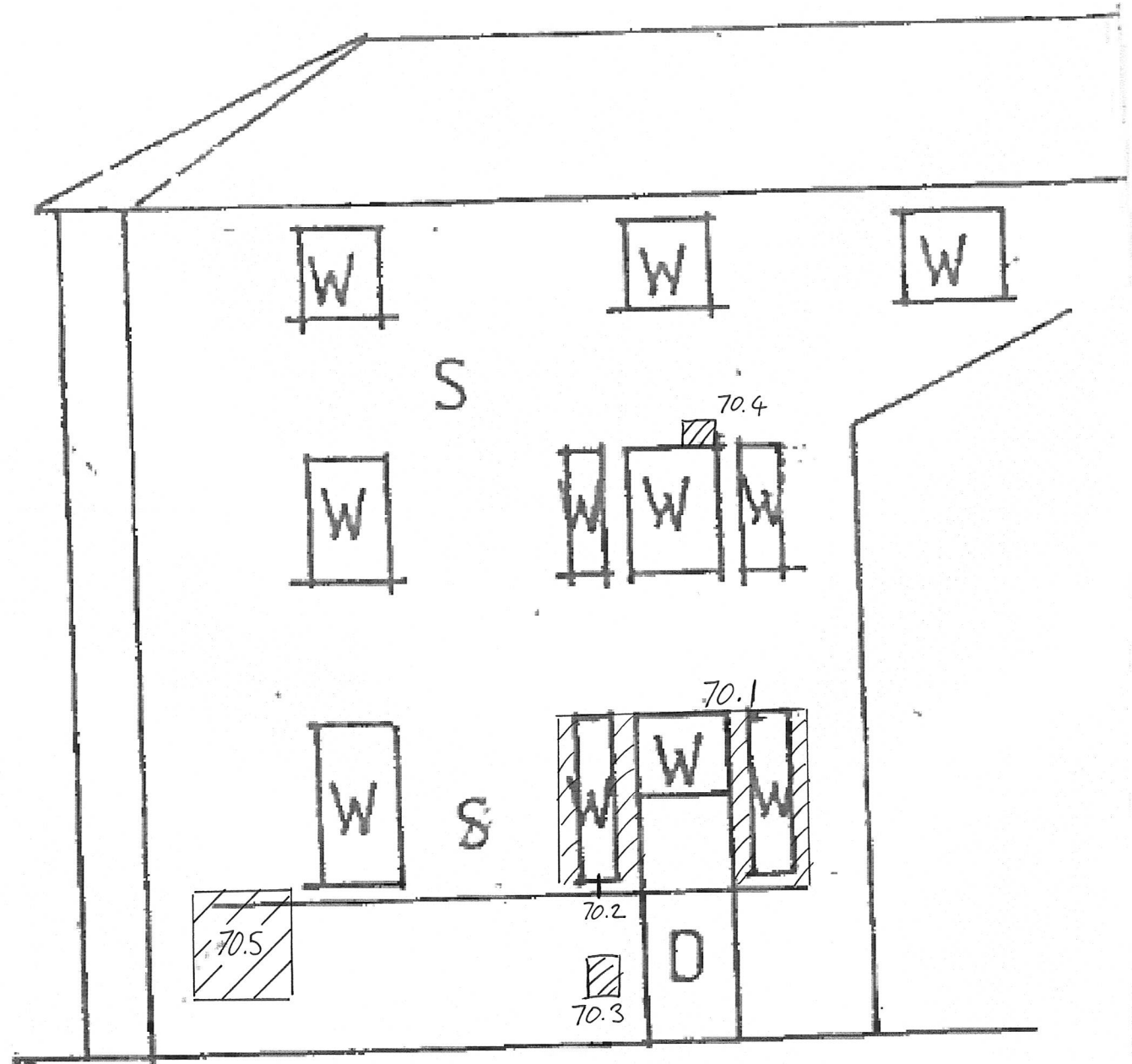

ELEVATION 70

(See layout plan for elevation reference.)

Key
 D → Door
 R – Render
 r – Railings
 S - Stone
 W - Window

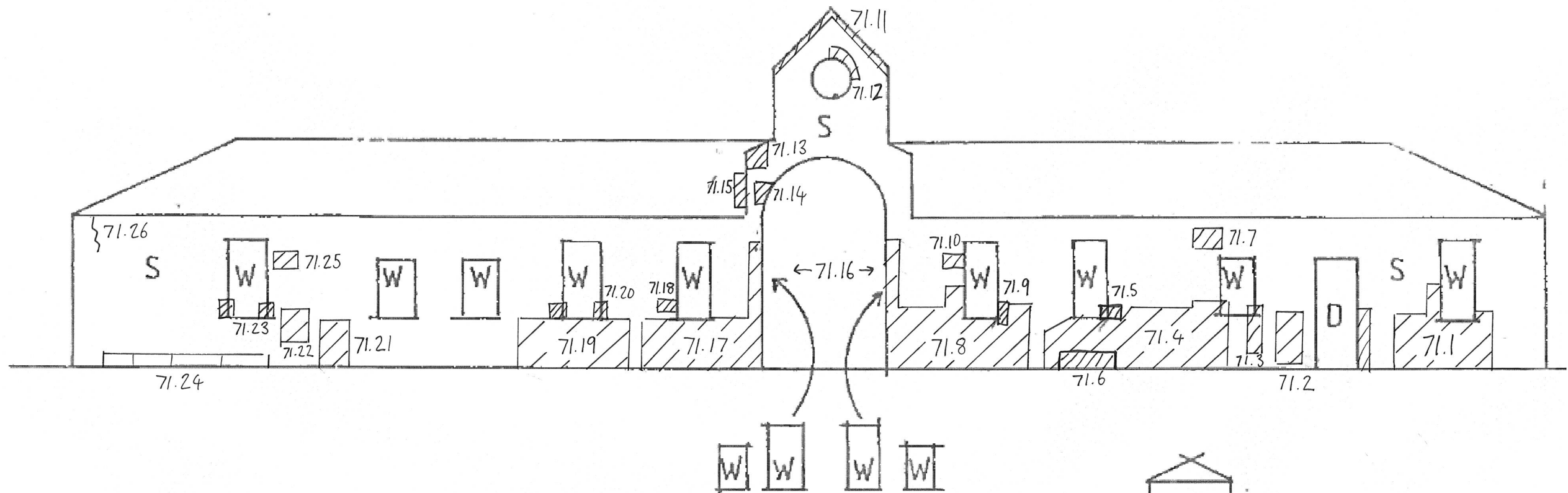

ELEVATION 71

(See layout plan for elevation reference.)

Key
D – Door
R – Render
r – Railings
S - Stone
W - Window

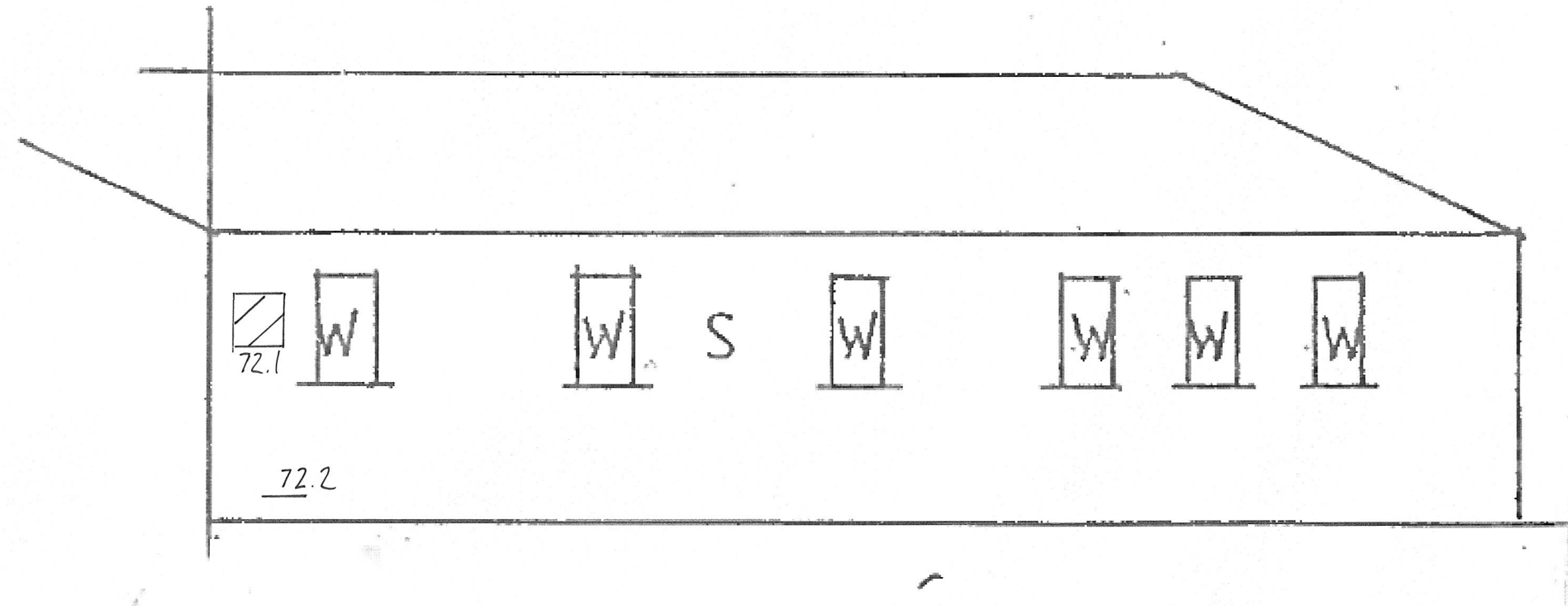

ELEVATION 72

(See layout plan for elevation reference.)

Key
D - Door
R - Render
r - Railings
S - Stone
W - Window

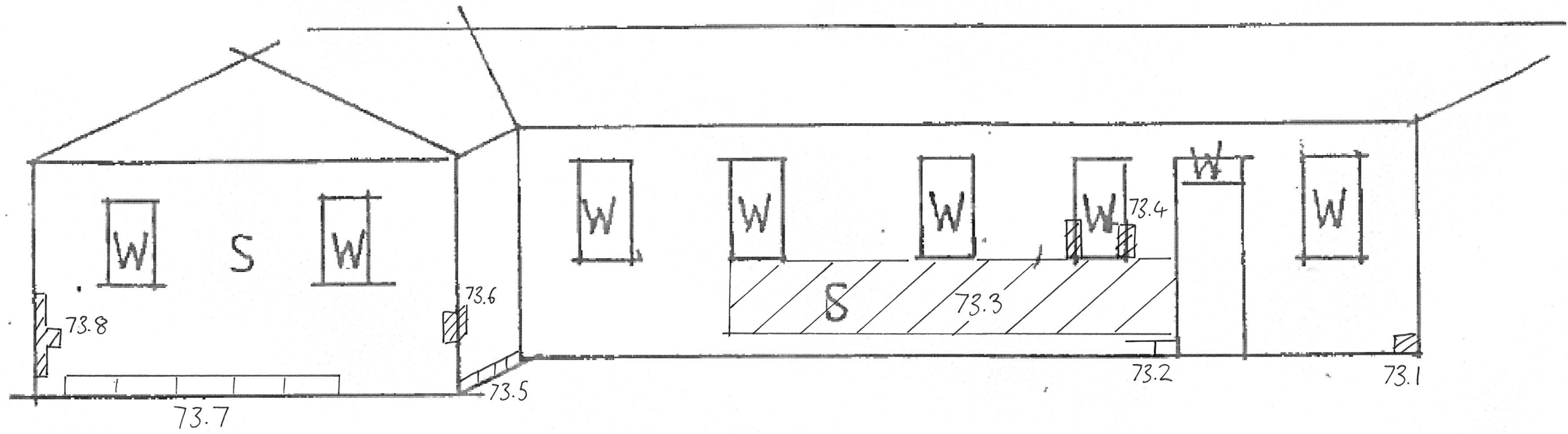

ELEVATION 73
(See layout plan for elevation reference.)

- Key
D – Door
R – Render
r – Railings
S - Stone
W - Window

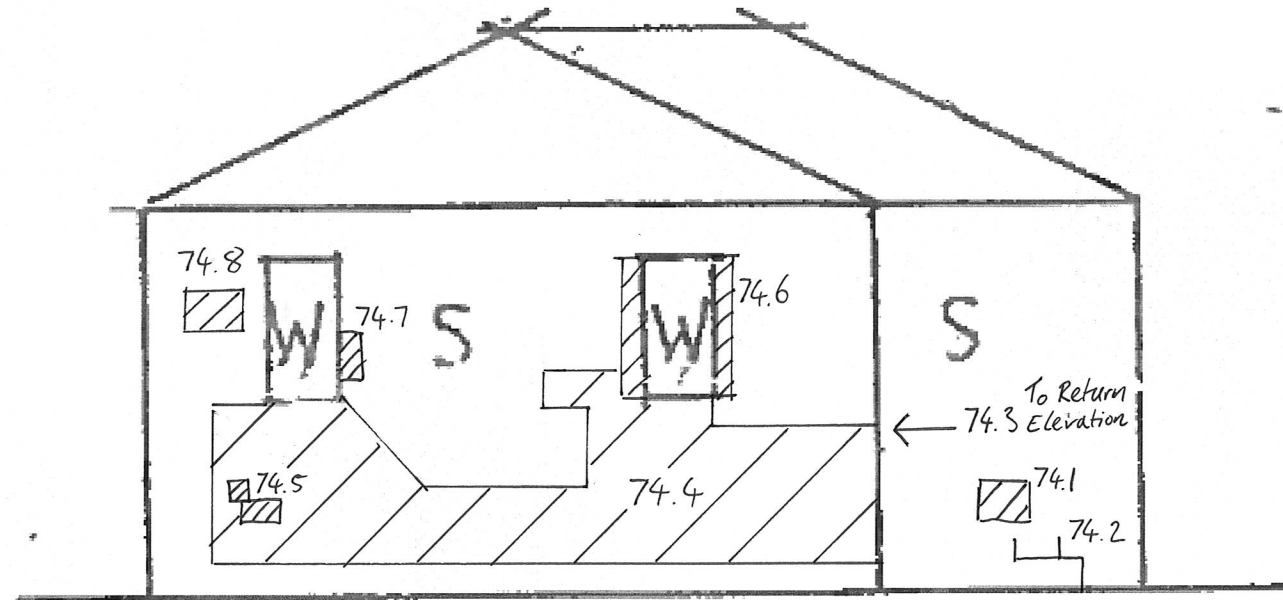

ELEVATION 74

(See layout plan for elevation reference.)

Key
D – Door
R – Render
r – Railings
S - Stone
W - Window

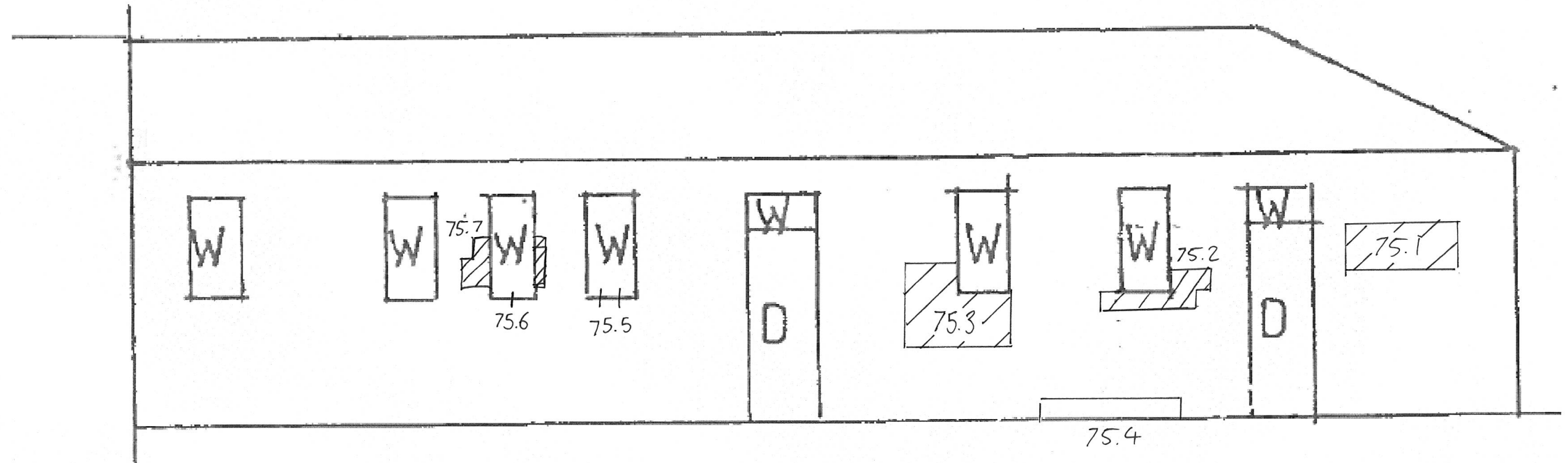

ELEVATION 75

(See layout plan for elevation reference.)

Key
D – Door
R – Render
r – Railings
S - Stone
W - Window

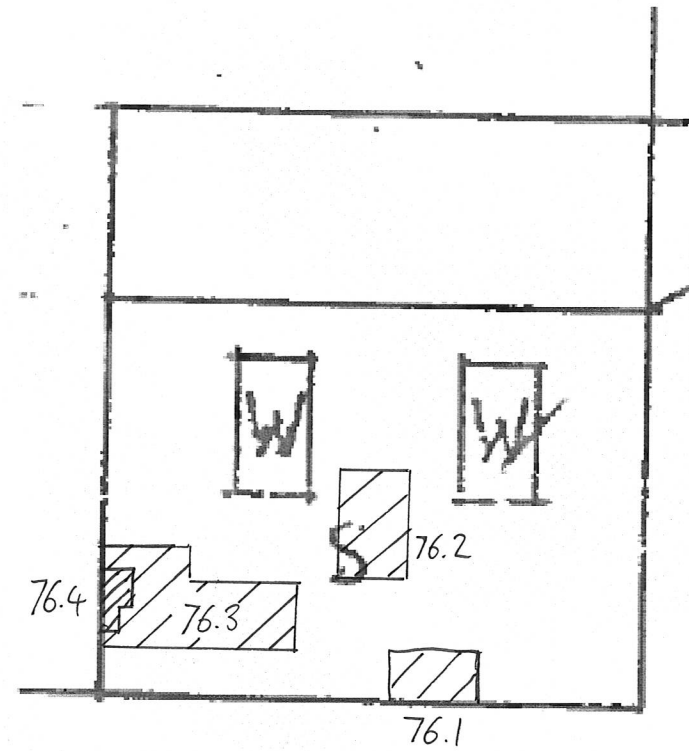

ELEVATION 76

(See layout plan for elevation reference.)

Key
D – Door
R – Render
r – Railings
S - Stone
W - Window

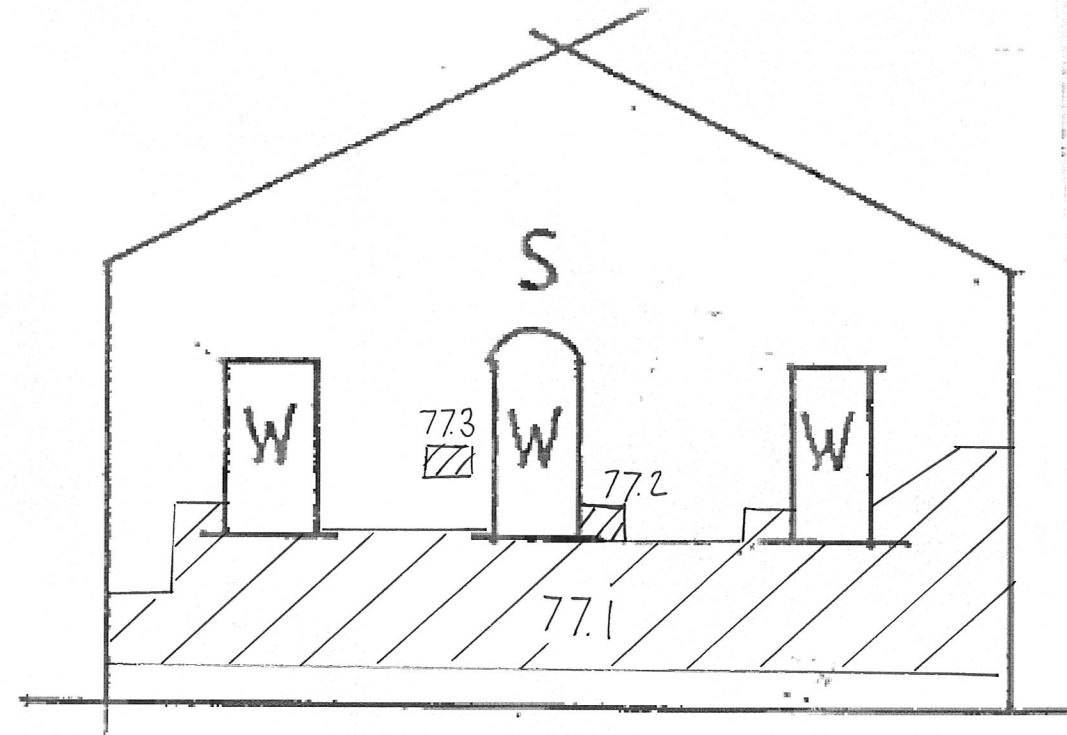

ELEVATION 77

(See layout plan for elevation reference.)

Key
D – Door
R – Render
r – Railings
S - Stone
W - Window

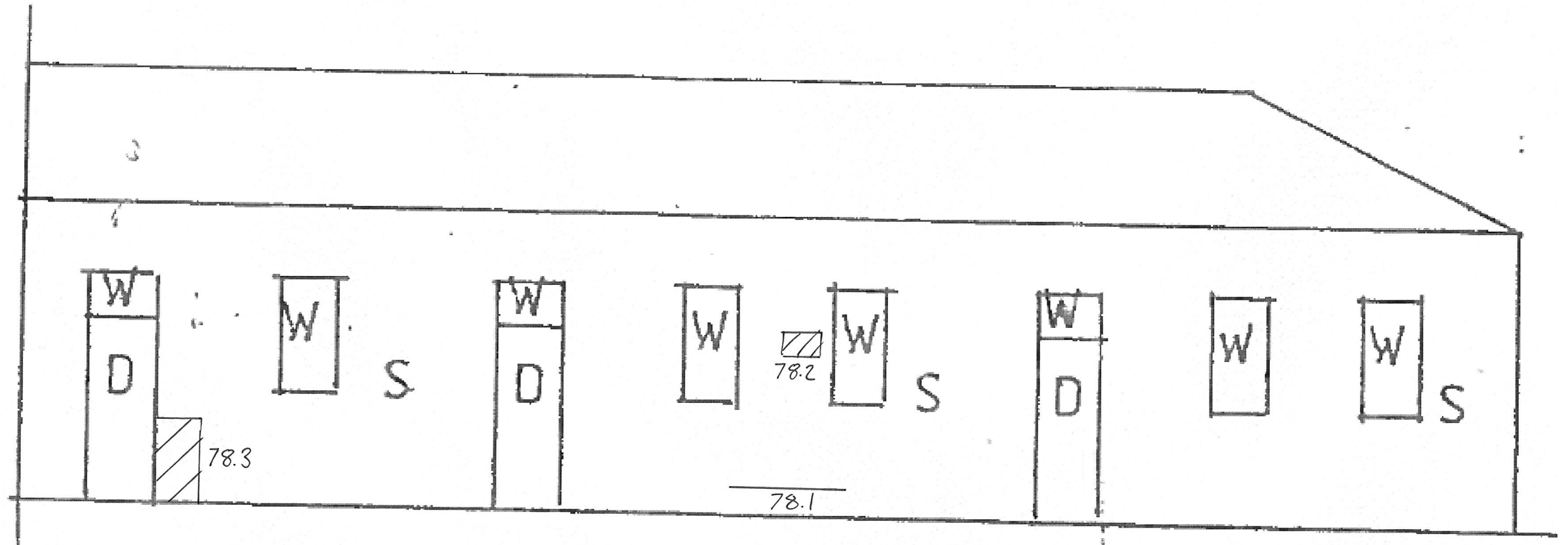

ELEVATION 78
(See layout plan for elevation reference.)

Key
 D – Door
 R – Render
 r – Railings
 S - Stone
 W - Window

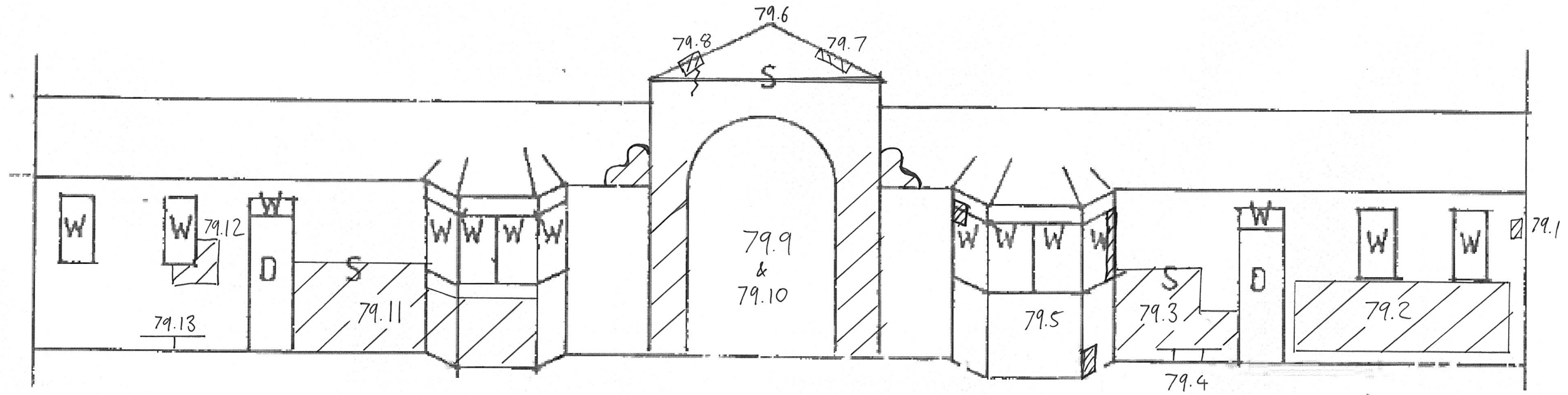

ELEVATION 79

(See layout plan for elevation reference.)

Key
D - Door
R - Render
r - Railings
S - Stone
W - Window

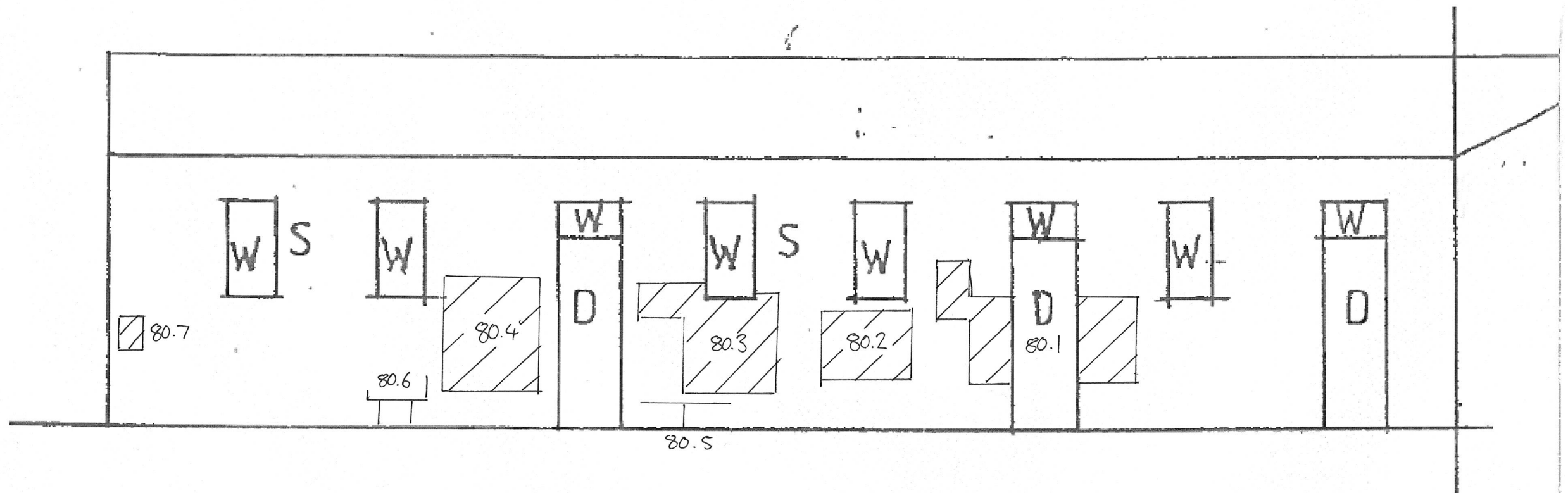

ELEVATION 80
(See layout plan for elevation reference.)